

Presse Nr. 36 Arbeitshöhe 150-500mm (Ständer-Abmessungen für Sonderarbeitshöhen gesondert anfordern)
Press No. 36 working height 150-500mm (measurements for special working heights upon request)

Maßblatt / Dimensions

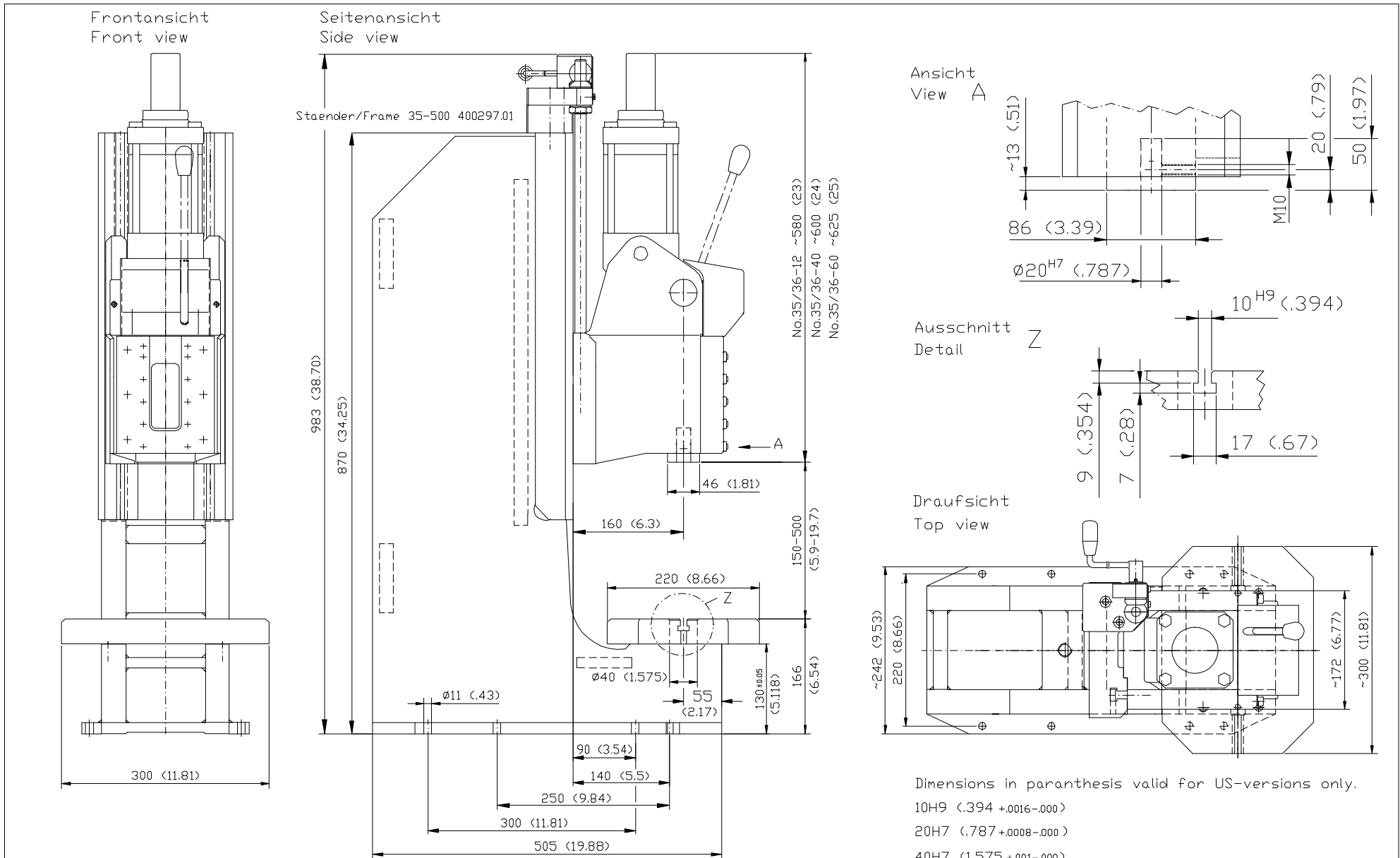

special ram hole upon request, for example Ø5/8"

Nr.36 - 15.09.06 TD-dj